

8614

KINGLO SAND



Information about the product







Dimensions	418 x 834 cm
Safety zone	746 x 1196 cm
Safety zone area	56,2 m ²
Overall height	840 cm
Free fall height	240 cm
Amount of users	20
Tallest element	470 cm
Heaviest element	40 kg
Product complies with EN 1176-1:2017-121:2017-12	Yes
Availability of spare parts	Yes
Age range	3-12

According to EN 1176-1:2017-12 norm, the product requires applying a safety surface according to the product's free fall height.

KINGLO ICE



Functions

-  Climbing
-  Balancing
-  Socializing
-  Sliding
-  Sensory Integration
-  Education panels

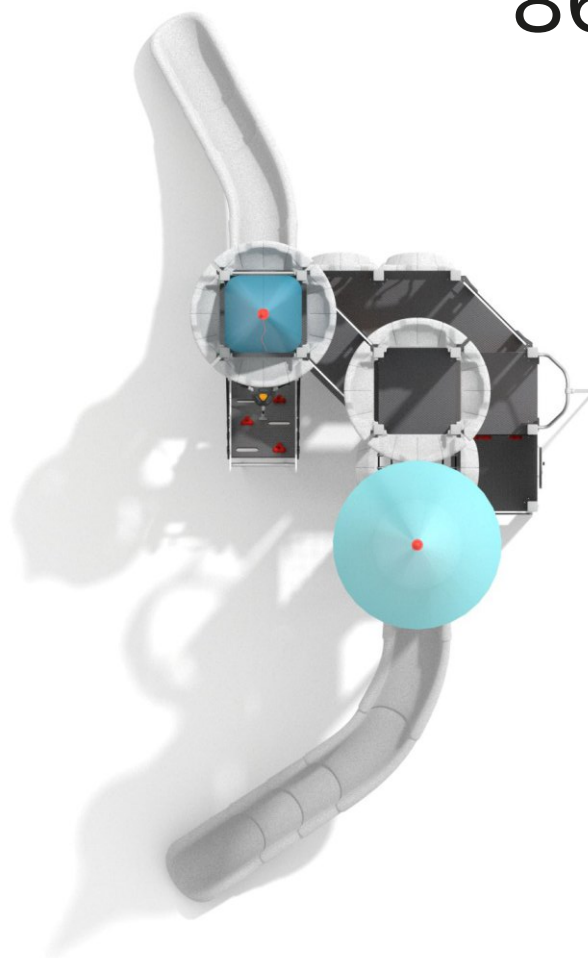
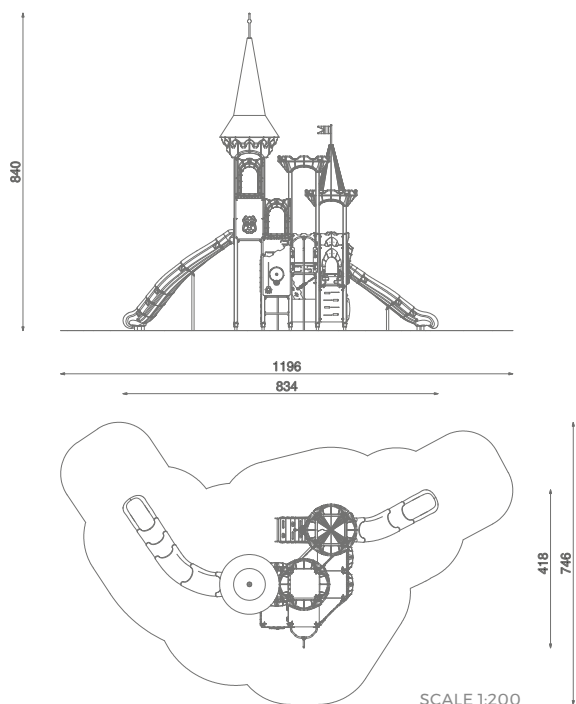

Materials



Wood from coniferous trees (Scandinavian spruce), with a cross-section of 90x90 mm, heartwood-free, layered with polyurethane adhesives completely resistant to moisture. The wood undergoes a three-stage impregnation process.



Elements made of stainless steel AISI304 totally resistant to various weather conditions.



Elements made of stainless steel AISI304 totally resistant to various weather conditions.



Anthracite non-slip HPL 18 mm panel with hexagonal structure characterized by maximum resistance to environmental factors and highest durability against abrasion.



Wall panels made of coloured, highest quality HPL 13 mm (black HPL 8mm), completely resistant to moisture and UV.



Wall panels made of high quality, coloured triple-layer HDPE 15 mm, resistant to moisture and UV.



16 mm diameter polypropylene ropes pp-multislip, with a steel core.



Elements made of LDPE material using rotomoulding technique.



LDPE rotomoulding window shutters with directly printed polycarbonate sheets inside.