

8351



BeBrave is a game that makes playtime even more exciting! It brings elements of the virtual world to the playground and combines traditional activity with a new, educational challenge.











Information about the product

Dimensions	ca. 1326 x 462 cm
Safety zone	ca. 1526 x 769 cm
Safety zone area	ca. 66,3 m ²
Overall height	ca. 880 cm
Free fall height	210 cm
Amount of users	30
Highest element	770 cm
Heaviest element	400 kg
Product complies with EN 1176-1:2017-12	Yes
Availability of spare parts	Yes
Age range	3-12

According to EN 1176-1:2017-12 norm, the product requires applying a safety surface according to the product's free fall height.



Functions

-  Climbing
-  Socializing
-  Grasping
-  Sliding
-  Emotion regulation
-  Courage
-  Logical thinking
-  Educational boards
-  Role-playing

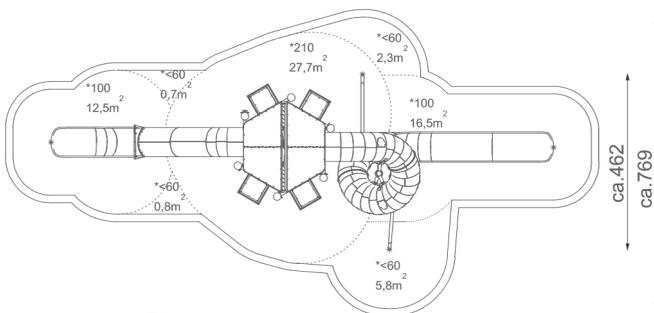
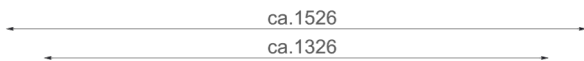
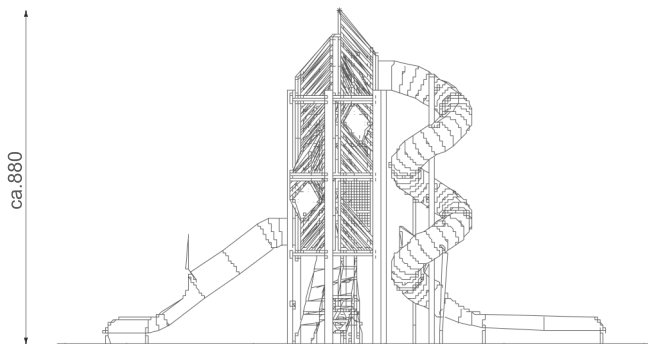

1:200

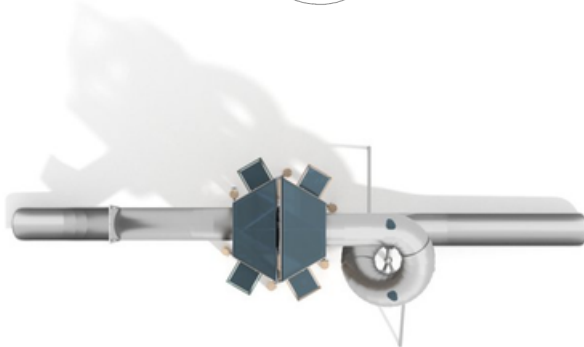

Due to the height of the free fall of the product, the EN 1176-1:2017-12 norm allows following types of fall-absorbing surfaces:

Material	Description	Minimal layer thickness mm
Bark	Chipped bark of coniferous trees (no wood-based materials), the size of the pieces between 20mm to 80mm	300
Wood chips	Mechanically fragmented wood without bark and leaves, size of the pieces between 5 mm to 30	300
Sand or gravel	Particle size between 0,25 mm to 8 mm	300
Synthetic material	Synthetic material with an approval for free fall heights \geq 210 cm	

All types of surfaces need to be preserved by adding bulk material and removing extraneous matters. Broken glass is considered to be most hazardous.

Installation method

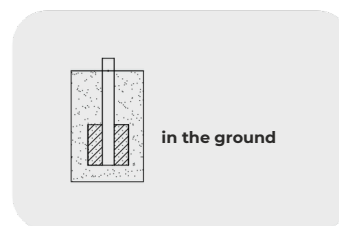

Warranty



Lifetime

The warranty covers the durability of components made of HDPE (high-density polyethylene), as well as the structural integrity of components made of black steel that has been powder galvanized and powder coated, stainless steel, and components made of hot-dip galvanized steel.



10 years

The Guaranty covers all flaws of the elements made of HPL, HDPE, stainless steel, hot-dip galvanized steel, wooden elements (pine, spruce), revealed during usage, which arise from manufacturing reasons.



5 years

The Guaranty covers all flaws of the elements made of powder coated steel, aluminum, laminate, ropes, elements made in rotomoulding technology, elements made of polyamid, polypropylene elements, revealed during usage, which arise from manufacturing reasons.



2 years

The Guaranty covers all flaws of the elements made of rubber, moving elements (bearings, joints), electronic elements, elements made of EPDM, elements made of plywood and other not mentioned before revealed during usage, which arise from manufacturing reasons.

Product description

Dimensions:

- Equipment Dimensions: ca. 1326 x 462 cm
- Safety zone: ca. 1526 x 769 cm
- Total height: 880 cm
- Free fall height: ca. 210 cm

Materials:

-**Natural posts** made of robinia wood, protected against splitting. The structure is constructed from beams with a diameter ranging between 20–25 cm and a length of 800 cm, which together with the platforms form the main framework. Robinia contains large quantities of oils, which act as an excellent natural preservative protecting the wood from decay and pests.

-**Construction** platforms made from three materials:

Frame made of stainless steel AISI 304 fabricated from pipes with diameters of 76.1 x 3 mm and 33.7 x 2 mm, cleaned by shot blasting

Platform made of robinia boards and reinforced 10 mm rubber with an anti-slip surface

-**Roof** made from coloured polycarbonate with a thickness of 5 mm

-**Tube slides** manufactured from stainless steel AISI 304, cleaned by shot blasting. Spiral slides are fitted with coloured polycarbonate windows 6 mm thick.

-Tower walls constructed from robinia boards and stainless steel AISI 304 mesh, fixed to the post by aluminium clamps, protected against corrosion by powder coating.

-**Diamond Passage** between tower levels made from a combination of 13 mm HPL, robinia boards, and 12 mm coloured polycarbonate. Inside the passage, climbing holds are made from a mixture of aggregates and coloured polyester resins.

-**Bars and handles** made of stainless steel AISI 304, tubes with a minimum diameter of 33.7 x 2.0 mm

-**Three-dimensional climbing net** made from 16 mm diameter polypropylene pp-multisplit rope with a steel core and components of reinforced 10 mm rubber with an anti-slip texture. Rope connectors made of injection-moulded polyamide.

-**All screws and fixings** exposed to weather conditions are made of stainless steel.

The device includes at minimum:

- 1 x Hexagonal tower with a height of 880 cm – platform heights: approx. 240, 445, and 650 cm
- 1 x Three-dimensional climbing net
- 1 x Roof
- 2 x Slides – platform heights: approx. 240 and 650 cm
- 4 x Diamond passages between tower levels

Materials

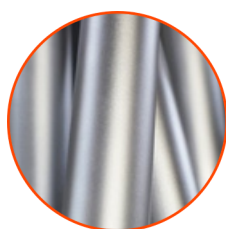

A solid structure made of AISI 304 stainless steel, cleaned using the glass bead blasting process, fully resistant to weather conditions.



Natural posts made of robinia acacia wood, protected against splitting.



Elements made of colourful 13 mm HPL, in the highest quality, totally damp-proof and resistant to UV.



Reinforced rubber, 10 mm thick, with a non-slip surface.

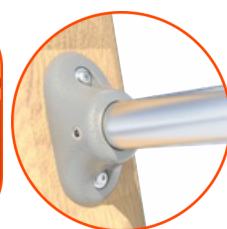

A system of connectors and clamps made of strong aluminium alloys.



Plates of the walls made of colourful triple layered 15 mm HDPE polyethylene, in the highest quality, totally damp-proof and resistant to UV.



Tube slides made of AISI 304 stainless steel, cleaned using a glass bead blasting process.



Polypropylene ropes PP - Multisplit type with a steel core and a diameter of 16 mm.



Polycarbonate panels with direct printing.



Elements made of coloured polycarbonate 5 and 12mm

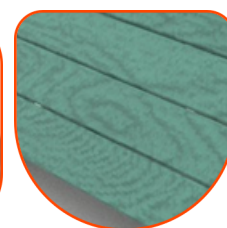

Robinia painted with a special water-based, fast-drying, vapour-permeable paint, providing a semi-gloss finish.