

8166

ROBINIA PLAY



SOCIALIZING



CLIMBING



BALANCING



SLIDING



SWINGING



INFORMATION ABOUT THE PRODUCT

| | |
|--|-----------------|
| Dimensions | ca.611 x 459 cm |
| Safety zone | ca.725 x 916 cm |
| Overall height | ca.435 cm |
| Free fall height | ca.150 cm |
| Amount of users | 6 person |
| Product complies with EN 1176-1:2017-12 | YES |
| Availability of spare parts | YES |
| Age range | 3-12 |
| The biggest element | 421 cm |
| The heaviest element | 140 kg |
| According to EN 1176-1:2017-12 norm, the product requires applying a safety surface according to the product's free fall height. | |

Visualisation is for reference only,
actual appearance may vary.





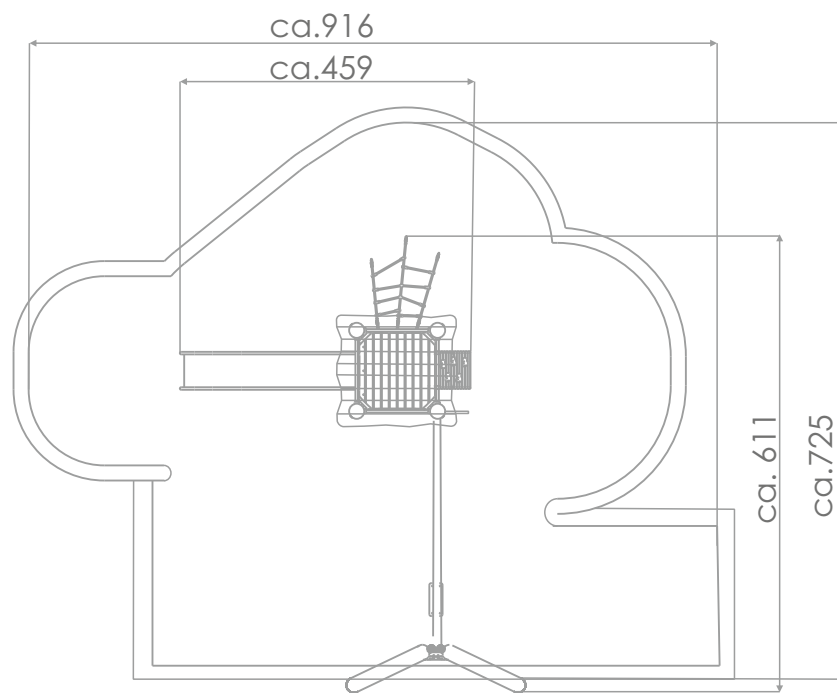
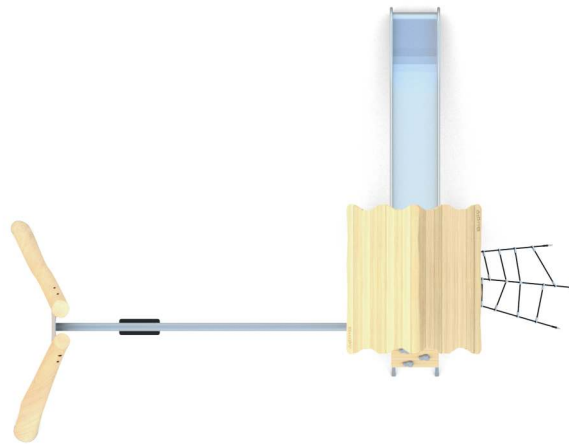





8166

ROBINIA PLAY

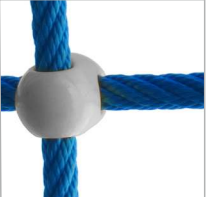

SCALE 1:100

MATERIALS:

| | | | | | |
|--|---|--|--|---|---|
| <p>NATURAL ROBINIA WOOD</p>  | <p>ELEMENTS CONSTRUCTION MADE OF STAINLESS STEEL AISI 304</p>  | <p>SLIDES MADE OF STAINLESS STEEL AISI 304</p>  | <p>SWINGS, SLINGS WITH DOUBLE BEARINGS MADE OF STAINLESS STEEL</p>  | <p>SEAT WITH A CONSTRUCTION MADE OF ALUMINIUM AND STAINLESS STEEL, DEDICATED FOR MOTHER AND CHILD</p>  | <p>BACK SUPPORT OF THE SEAT WITH STEEL CONSTRUCTION COVERED WITH SOFT POLYURETHANE</p>  |
| <p>SOLID CONSTRUCTION MADE OF BLACK STEEL S235JR, CLEANED IN THE SANDBLASTING PROCESS</p>  | <p>POLYPROPYLENE ROPES PP - MULTISPLIT TYPE WITH A STEEL CORE AND A DIAMETER OF 16 MM</p>  | <p>ROPE ENDINGS PRESSED IN A SLEEVE MADE OF DURABLE ALUMINUM ALLOY</p>  | <p>SOLID AND ESTHETIC ROPE CONNECTORS MADE OF INJECTION MOLDED POLYAMIDE</p>  | <p>THE SEATS ARE MADE WITH AN ALUMINIUM CONSTRUCTION COVERED WITH A SOFT EPDM RUBBER</p>  | <p>SAFETY SEAT MADE OF ALUMINIUM AND STAINLESS STEEL COVERED WITH SOFT POLYURETHANE</p>  |

OPTIONAL: