

# 8176

## ROBINIA PLAY

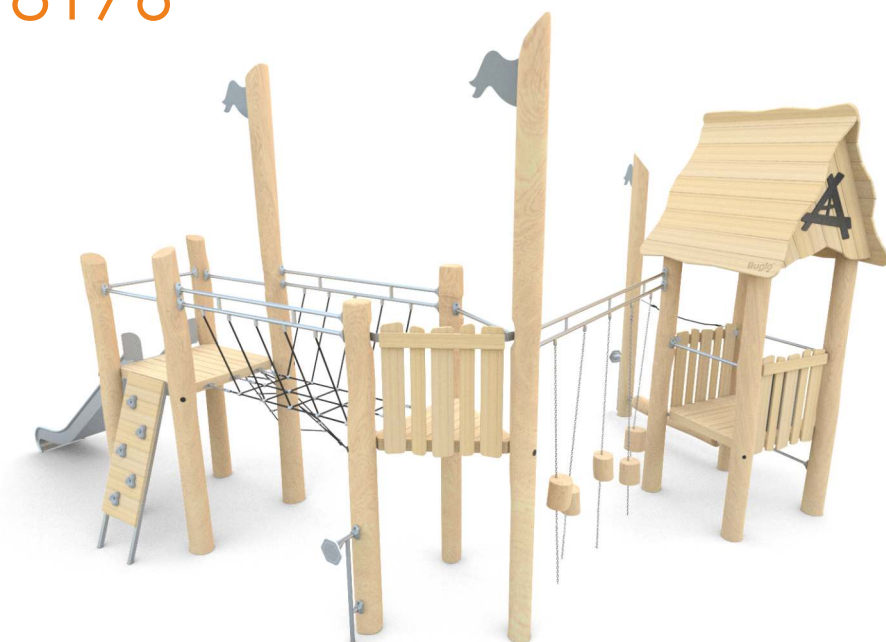

SOCIALIZING



SLIDING



CLIMBING



SENSORIAL  
INTEGRATION



### INFORMATION ABOUT THE PRODUCT

|   |                  |
|---|------------------|
| Dimensions  | ca.802 x 597 cm  |
| Safety zone   | ca.1154 x 897 cm |
| Overall height  | ca.412 cm        |
| Free fall height  | ca.150 cm        |
| Amount of users   | 21 person        |
| Product complies with PN-EN 1176-1:2017-12  | YES              |
| Availability of spare parts   | YES              |
| Age range   | 3-12             |
| The biggest element:  | 482 cm           |
| The heaviest element:   | 158 kg           |
| <small>According to EN 1176-1:2017-12 norm, the product requires applying a safety surface according to the product's free fall height.</small> |                  |

Visualisation is for reference only,  
actual appearance may vary.







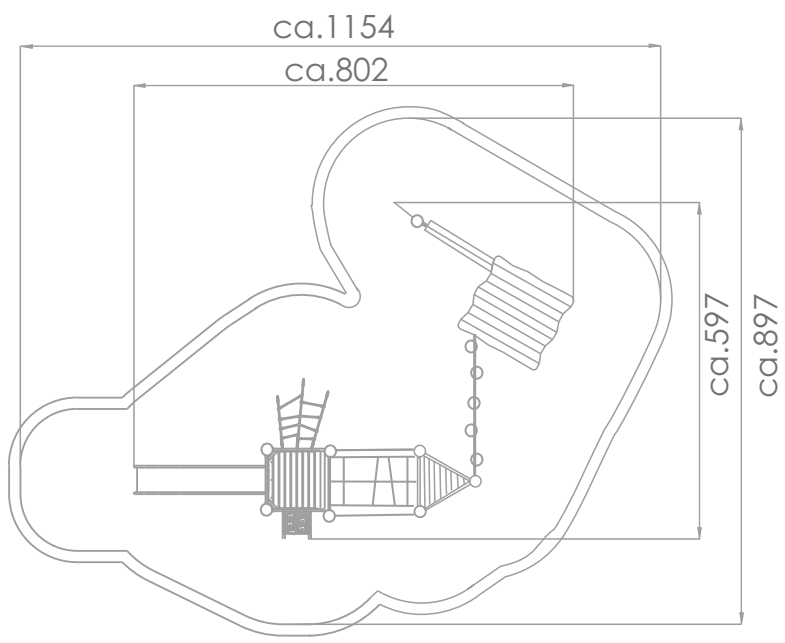
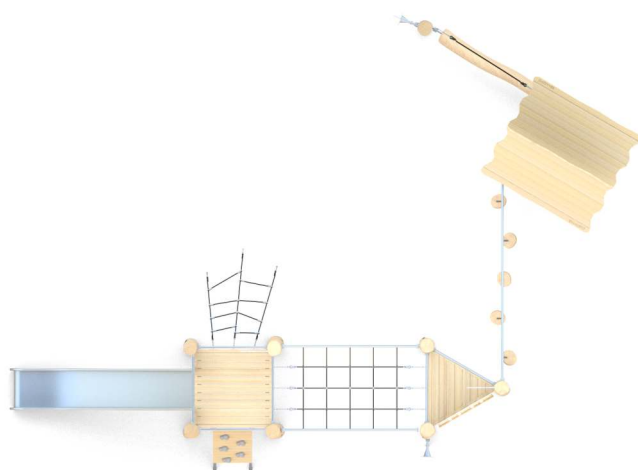



# 8176

# ROBINIA PLAY



SCALE 1:125

## MATERIALS:

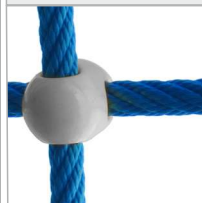
|  |   |   |  |   |
|--|---|---|--|---|
| <p>NATURAL ROBINIA WOOD</p>    | <p>ELEMENTS CONSTRUCTION MADE OF STAINLESS STEEL AISI 304</p>  | <p>PLATES OF THE WALLS MADE OF GREY TRIPLE LAYERED 15 MM HDPE POLYETHYLENE</p>             | <p>SLIDES MADE OF STAINLESS STEEL AISI 304</p>                          |   |
| <p>CLIMBING ROCKS MADE OF CHIPPINGS AND COLOURFUL POLYESTER RESIN</p>  | <p>ATTESTED 6 MM STAINLESS STEEL CHAINS</p>                    | <p>POLYPROPYLENE ROPES PP - MULTISPLIT TYPE WITH A STEEL CORE AND A DIAMETER OF 16 MM</p>  | <p>ROPE ENDINGS PRESSED IN A SLEEVE MADE OF DURABLE ALUMINUM ALLOY</p>  | <p>SOLID AND ESTHETIC ROPE CONNECTORS MADE OF INJECTION MOLDED POLYAMIDE</p>  |

