

3023



SOCIALIZING



SWINGING

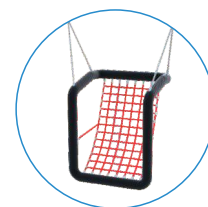

INFORMATION ABOUT THE PRODUCT

Dimensions	185 x 289 cm
Safety zone	750 x 235 cm
Safety zone area	18 m <sup>2</sup>
Overall height	244 cm
Free fall height	133 cm
Amount of users	4
Product complies with EN 1176-1:2017-12	YES
Availability of spare parts	YES
Age range	3-12



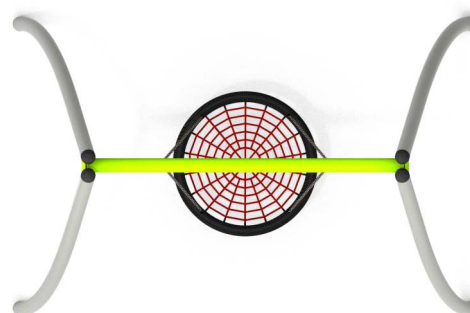

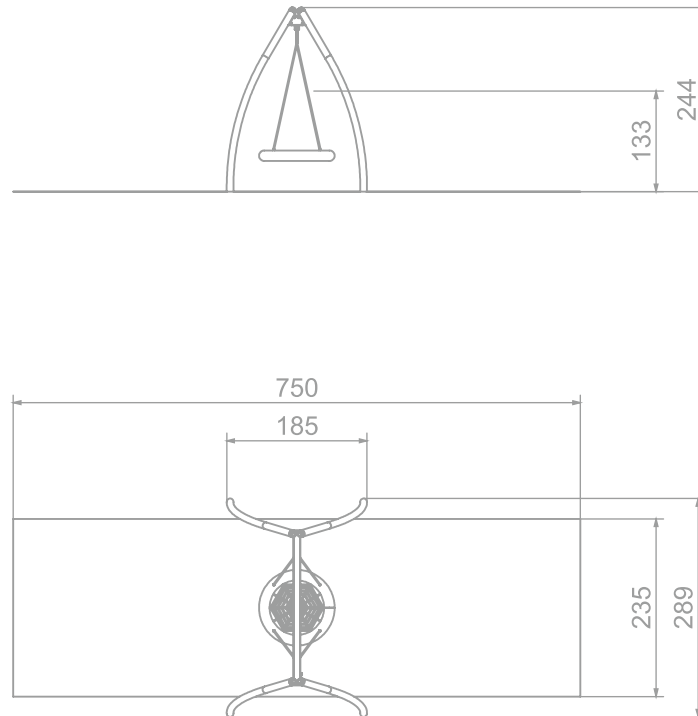
According to EN 1176-1:2017-12 norm, the product requires applying a safety surface according to the product's free fall height.



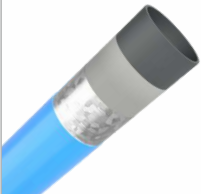

SCALE 1:100

### MATERIALS:

<p>SOLID CONSTRUCTION MADE OF BLACK STEEL IS235JR, CLEANED THE SANDBLASTING PROCESS</p>	<p>„BRD NEST“ TYPE SEAT WITH A DIAMETER OF 100 CM, HANGED ON 6 MM STAINLESS STEEL CHAINS</p>
	
<p>POST ENDINGS FINISHED WITH SOFT EPDM RUBBER</p>	<p>SWING SLINGS, WITH DOUBLE BEARINGS</p>
	

### OPTIONAL:

<p>APPROVED SEAT – SEAT TYPE – HANGED ON R 6 MM CHAINS MADE OF STAINLESS STEEL. METAL FRAME COVERED BY SOFT POLYPROPYLENE ROPE</p>	<p>APPROVED SEAT MADE WITH ROTOMOULDED METHOD, DEDICATED FOR DISABLED USERS</p>
	