

1710_{INOX}



SLIDING



SOCIALIZING



CLIMBING



INFORMATION ABOUT THE PRODUCT

Dimensions	775 x 373 cm
Safety zone	1125 x 758 cm
Safety zone area	51,2 m ²
Overall height	422 cm
Free fall height	210 cm
Amount of users	15
Product complies with EN 1176-1:2017-12	YES
Availability of spare parts	YES
Age range	3-12
According to EN 1176-1:2017-12 norm, the product requires applying a safety surface according to the product's free fall height.	







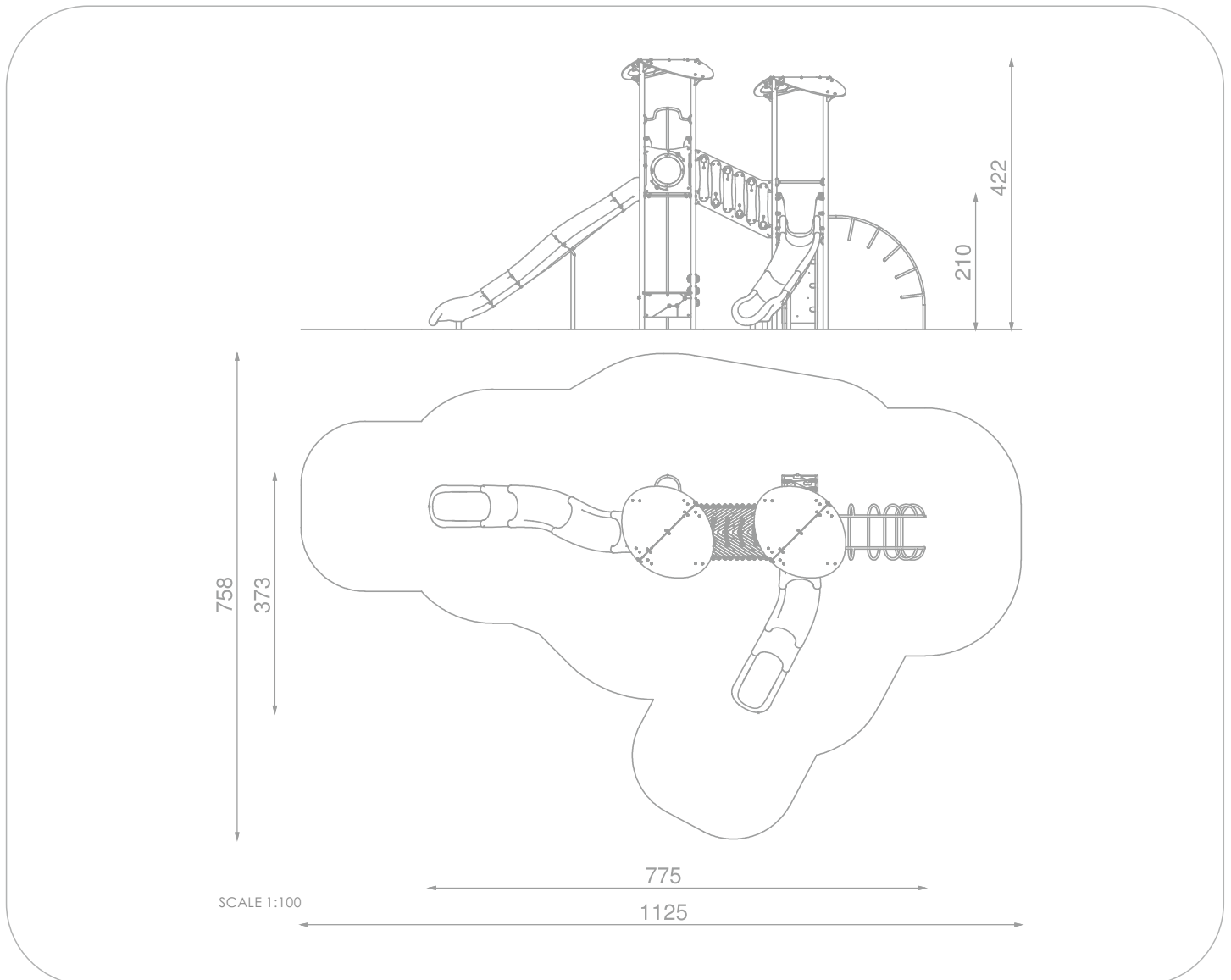

1710_{INOX}

INFORMATION FOR ARCHITECTS



MATERIALS:

CONSTRUCTION MADE OF STAINLESS STEEL AISI 304	PLATES OF THE WALLS MADE OF COLOURFUL TRIPLE LAYERED 15 MM HDPE POLYETHYLENE	HEMISPHERIC WINDOW WITH A DIAMETER OF 400 MM	SYSTEM OF CONNECTORS AND CLAMPS MADE OF STRONG ALUMINUM ALLOY
			
PLATES OF THE WALLS AND PLATFORMS MADE OF COLOURFUL 13 MM HPL	MODULAR POLYETHYLENE SLIDES MADE OF ROTOMOULDED LDPE TYPE MATERIAL	PLATE AND ROPE CONNECTORS MADE OF INJECTION MOLDED POLYAMIDE	CLIMBING ROCKS MADE OF CHIPPINGS AND COLOURFUL POLYESTER RESIN
			THE TIC TAC TOE GAME IS MADE OF POLYETHYLENE ROTATIONALLY MOLDED WITH SYMBOLS ON THE FORM
			