

5105

SINGLE



INFORMATION ABOUT THE PRODUCT

Dimensions	91 x 30 cm
Safety zone	351 x 230 cm
Safety zone area	7,23 m ²
Overall height	88 cm
Free fall height	50 cm
Amount of users	1
Product complies with PN-EN 1176-1:2017-12	YES
Availability of spare parts	YES
Age range	1-12
According to PN-EN 1176-1:2017-12 norm, the product requires applying a safety surface according to the product's free fall height.	



5105

SINGLE

INFORMATION FOR ARCHITECTS

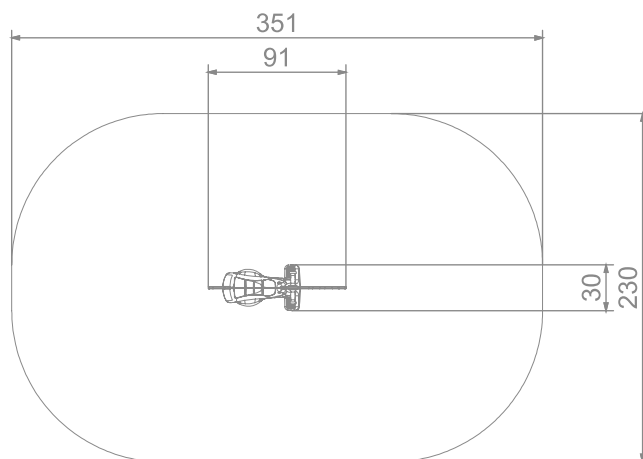
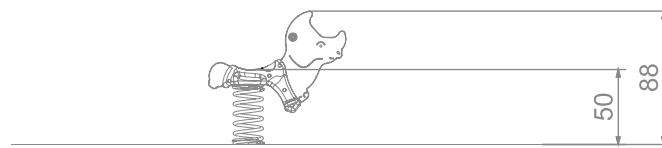

SCALE 1:50

MATERIALS:

HANDHOLD MADE OF INJECTION MOLDED POLYAMIDE



CONNECTING ELEMENTS LIKE SCREWS, NUTS, WASHERS MADE OF STAINLESS STEEL



PLATES OF THE WALLS MADE OF COLOURFUL TRIPLE LAYERED 1.5 MM HDPE POLYETHYLENE



SPRINGERS' SPRINGS MADE OF SPRING STEEL

