

5108

SINGLE



INFORMATION ABOUT THE PRODUCT

Dimensions	82 x 30 cm
Safety zone	342 x 230 cm
Safety zone area	7,02 m ²
Overall height	86 cm
Free fall height	50 cm
Amount of users	1
Product complies with PN-EN 1176-1:2017-12	YES
Availability of spare parts	YES
Age range	1-12
According to PN-EN 1176-1:2017-12 norm, the product requires applying a safety surface according to the product's free fall height.	

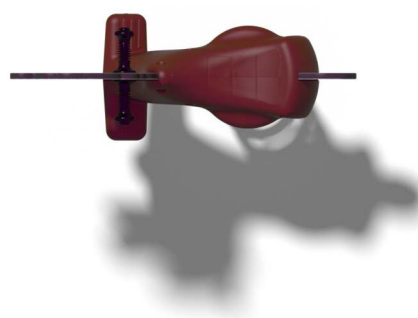

5107

SINGLE

INFORMATION FOR ARCHITECTS

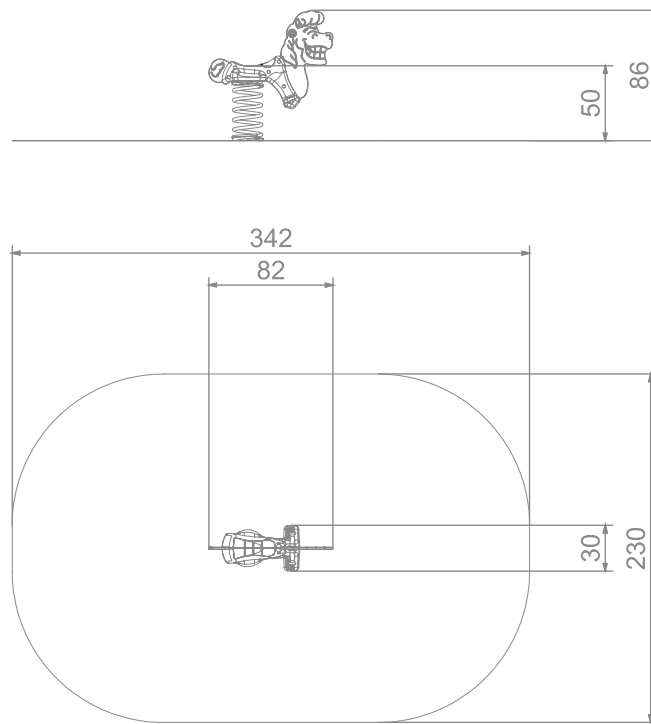

SCALE 1:50

MATERIALS:

HANDHOLD MADE OF INJECTION MOLDED POLYAMIDE



CONNECTING ELEMENTS LIKE SCREWS, NUTS, WASHERS MADE OF STAINLESS STEEL



PLATES OF THE WALLS MADE OF COLOURFUL TRIPLE LAYERED 1.5 MM HDPE POLYETHYLENE



SPRINGERS' SPRINGS MADE OF SPRING STEEL

