

7108

MINI

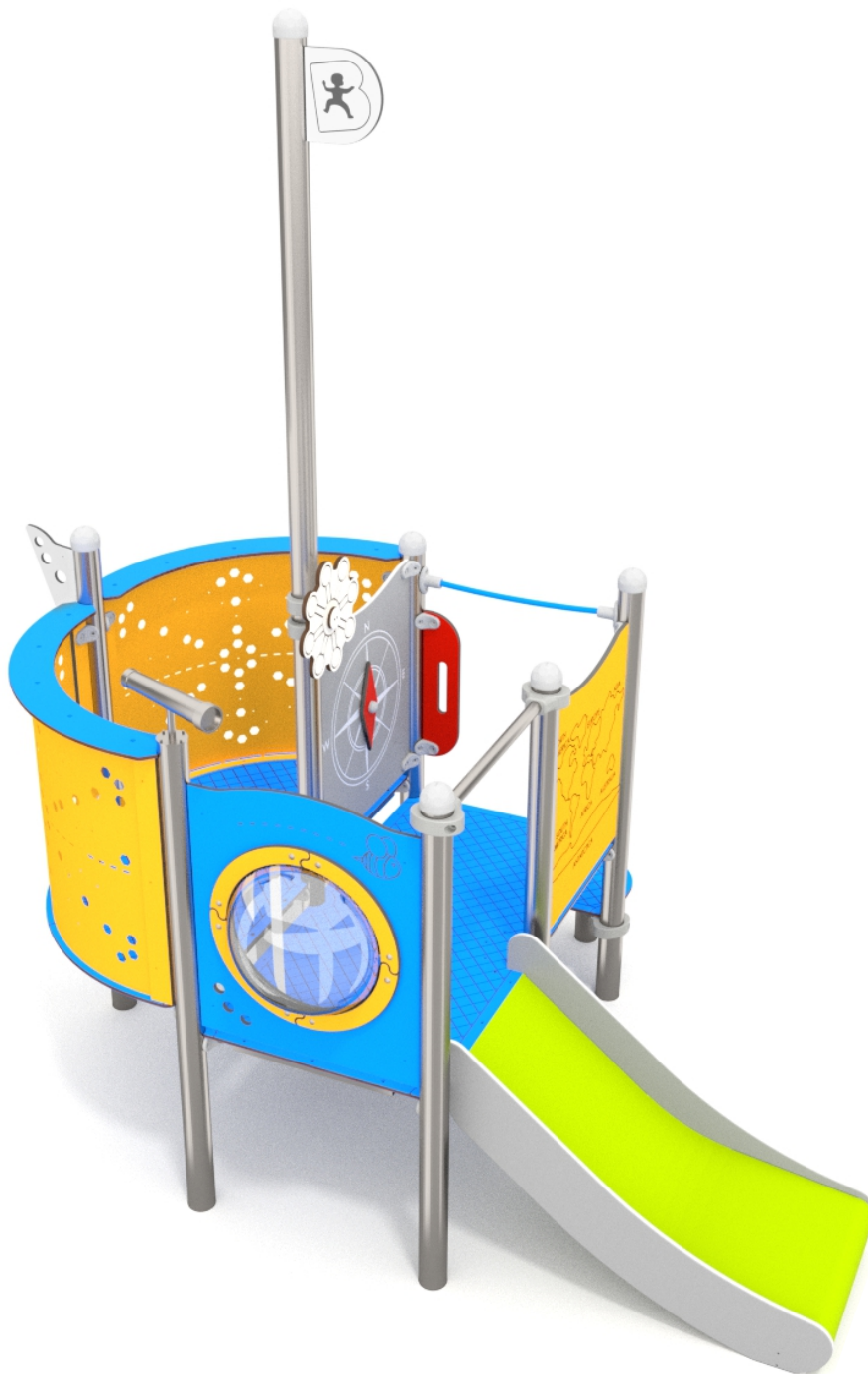

SLIDING



SOCIALIZING



SENSORY INTEGRATION



JUMPING

INFORMATION ABOUT THE PRODUCT

Dimensions	192 x 263 cm
Safety zone	492 x 613 cm
Safety zone area	22,13 m ²
Overall height	274 cm
Free fall height	67 cm
Amount of users	10
Product complies with EN 1176-1:2017-12	YES
Availability of spare parts	YES
Age range	1-8

According to EN 1176-1:2017-12 norm, the product requires applying a safety surface according to the product's free fall height.

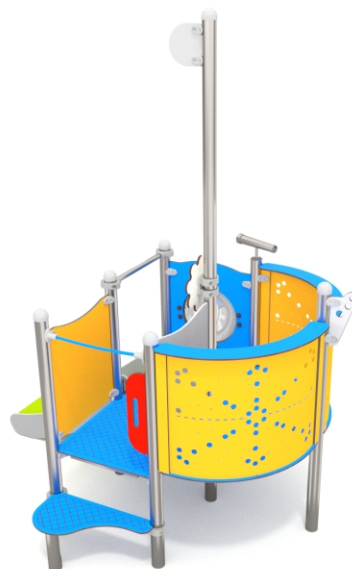





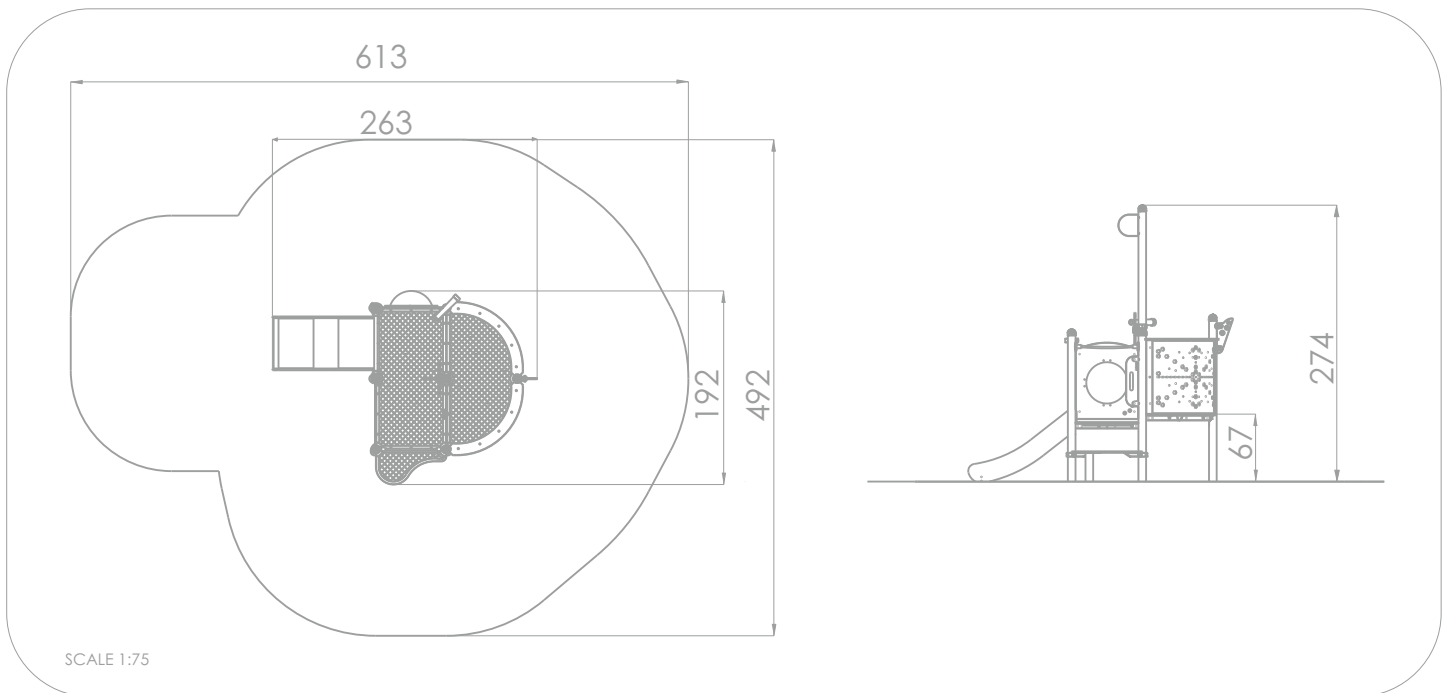
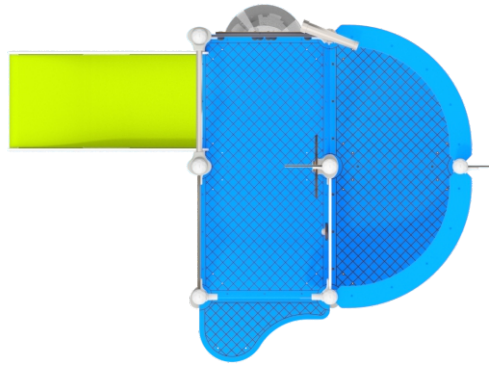

7108

MINI

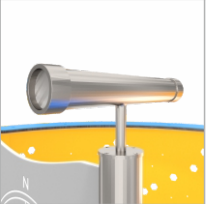

MATERIALS:

<p>STEEL CONSTRUCTION: STAINLESS STEEL AISI304</p>	<p>PLATES: HDPE 15 MM</p>	<p>ROTARY MODULE, WHICH ALLOWS TO MOVE THE BALL IN THE MAZE</p>	<p>MILLED EDUCATIONAL BOARD MADE OF HDPE BOARD WITH A THICKNESS OF 15 MM</p>	<p>SPYGLASS MODULE MADE OF AISI 304 STAINLESS STEEL AND SAFE POLYCARBONATE</p>	<p>MILLED EDUCATIONAL BOARD MADE OF 15 MM THICK HDPE BOARD WITH A MOVABLE ROTATING ELEMENT</p>
					
<p>ELEMENTS: HPL 13 MM</p>	<p>SLIDES FOR SMALL CHILDREN MADE OF POLYESTER RESIN. SLIDEPANELS MADE OF HDPE POLYETHYLENE 15 MM, RESISTANT TO UV</p>	<p>PLATE AND ROPE CONNECTORS AND SAFE PIPE PLUGS MADE OF INJECTION MOLDED POLYAMIDE</p>	<p>PERFORATED STEEL SHEET GALVANISED AND POWDER COATED WITH POLYESTER PAINT QUALICOAT ATTESTED</p>	<p>ROTARY MODULE, MADE OF 13 MM HPL PLATES</p>	<p>HEMISPHERIC WINDOW WITH A DIAMETER OF 400 MM</p>
