

9105

ACROBAT



SOCIALIZING



CLIMBING

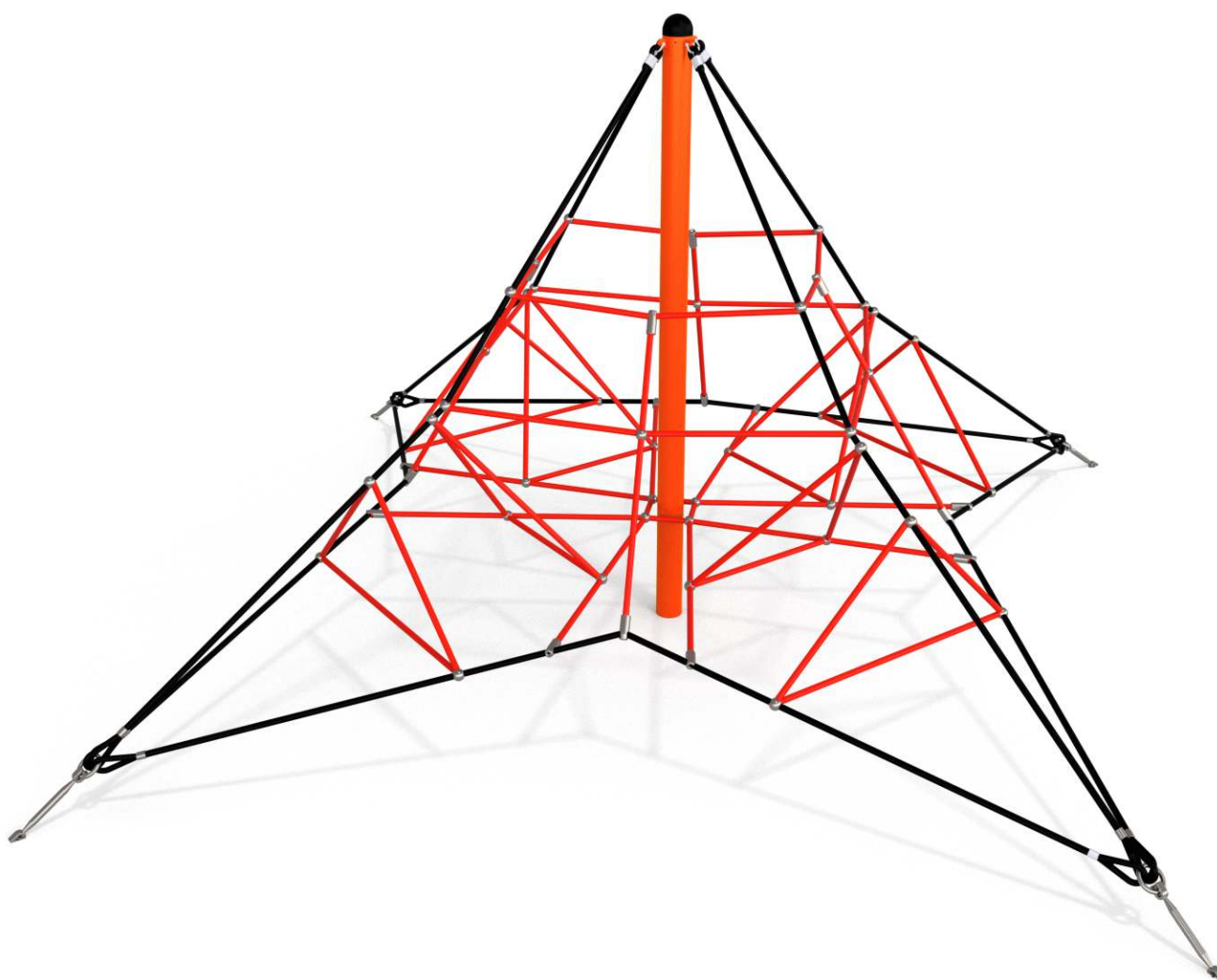

INFORMATION ABOUT THE PRODUCT

Dimensions	449 x 449 cm
Safety zone	750 x 750 cm
Safety zone area	37 m ²
Overall height	200cm
Free fall height	40 cm
Amount of users	6
Product complies with EN 1176-1:2017-12	YES
Availability of spare parts	YES
Age range	3-12
According to EN 1176-1:2017-12 norm, the product requires applying a safety surface according to the product's free fall height.	

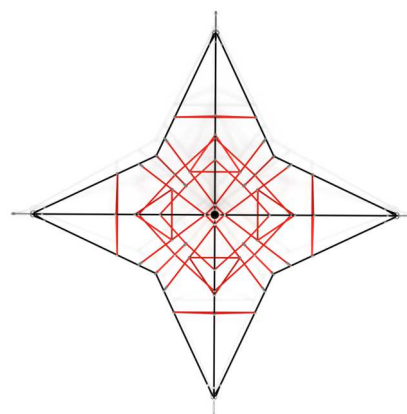

9105



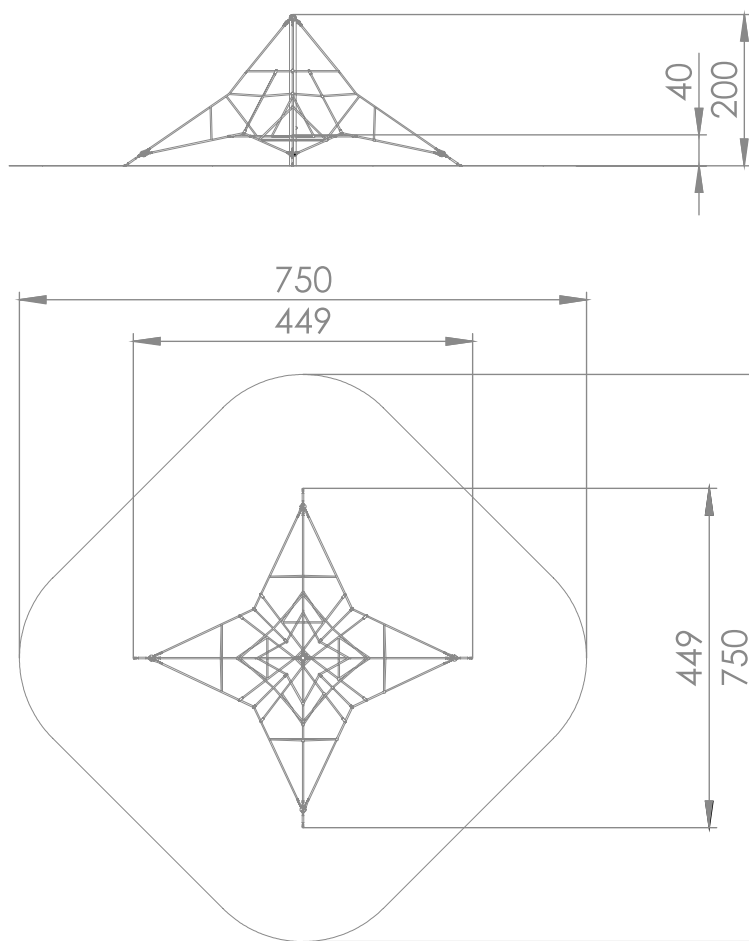

ACROBAT

INFORMATION FOR ARCHITECTS



SCALE 1:100

MATERIALS:

<p>SOLID CONSTRUCTION MADE OF BLACKSTEEL S235JR, CLEANED IN THE SANDBLASTING PROCESS</p>	<p>ROPE ENDINGS PRESSED IN A SLEEVE MADE OF DURABLE ALUMINUM ALLOY</p>	<p>PYRAMID TENSIONER MATERIAL: HOT - DIP GALVANISED STEEL</p>	<p>POST ENDINGS FINISHED WITH SOFT EPDM RUBBER</p>
			
<p>SOLID AND ESTHETIC ROPE CONNECTORS MADE OF INJECTION MOLDED POLYAMIDE</p>	<p>ROPE CROSS BRACING SYSTEM DEDICATED FOR USE IN ELEMENTS WITH REQUIREMENT OF HIGH DURABILITY</p>	<p>POLYPROPYLENE ROPES PP - MULTISPLIT TYPE WITH A STEEL CORE AND A DIAMETER OF 16 MM</p>	
