

8075

ECO



SOCIALIZING



CLIMBING



SLIDING

INFORMATION ABOUT THE PRODUCT

Dimensions	240 x 394 cm
Safety zone	542 x 744 cm
Safety zone area	29 m ²
Overall height	314 cm
Free fall height	150 cm
Amount of users	7
Product complies with EN 1176-1:2017-12	YES
Availability of spare parts	YES
Age range	3-12

According to EN 1176-1:2017-12 norm, the product requires applying a safety surface according to the product's free fall height.

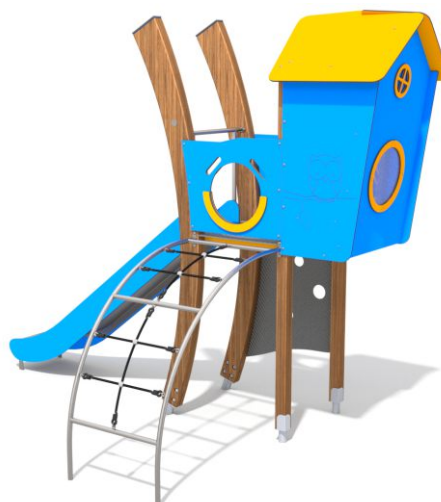





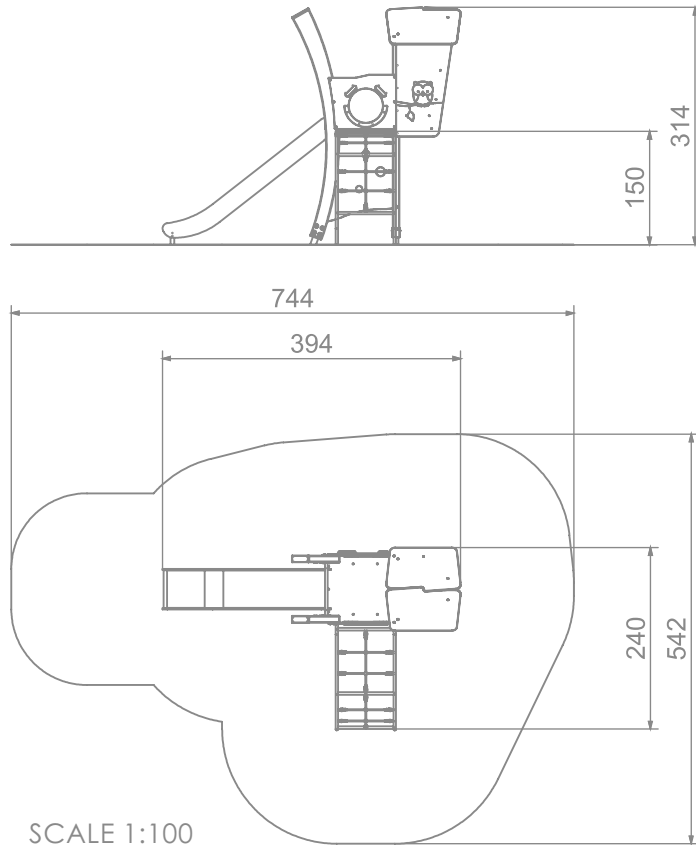
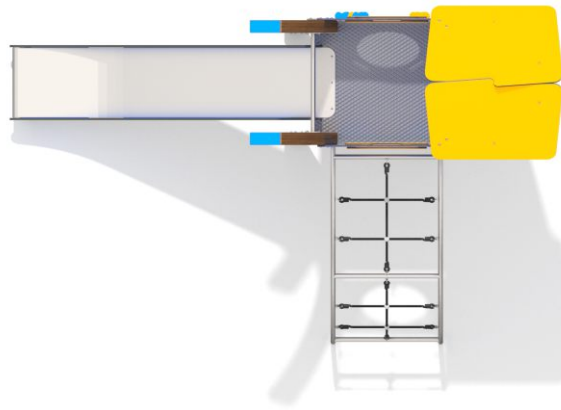

8075

ECO



SCALE 1:100

MATERIALS:

<p>SOFT CONIFER WOOD CORELESS, GLUED IN LAYERS WITH POLYURETHANE GLUES, TOTALLY RESISTANT TO WATER.</p>	<p>WOODEN POSTS ANCHORED TO THE GROUND WITH POWDER GALVANIZED AND POWDER COATED STEEL ANCHORS.</p>	<p>PATENTED SYSTEM OF CONNECTORS AND CLAMPS MADE OF STRONG ALUMINIUM ALLOY.</p>	<p>BENDED POSTS MADE OF SOFT CONIFER WOOD.</p>	<p>PLATES OF THE WALLS MADE OF COLOURFUL TRIPLE LAYERED 15 MM HDPE POLYETHYLENE, IN THE HIGHEST QUALITY, TOTALLY DAMP-PROOF.</p>	<p>POLIPROPYLENE ROPES PPMULTISPLIT TYPE WITH A STEEL CORE AND A DIMETER OF 16 MM.</p>
					
<p>ANTI-SLIP ANTHRACITE 10MM HPL PLATFORM PLATE WITH A VERY HIGH RESISTANCE TO WEATHER CONDITIONS AND ATTRITION.</p>	<p>SLIDES MADE OF STAINLESS STEEL AISI 304. METAL SHEET WITH A THICKNESS OF 2 MM FORMED IN A CNC TECHNIQUE.</p>	<p>HEMISPHERIC WINDOW WITH A DIAMETER OF 400 MM.</p>	<p>CLIMBING ROCKS MADE OF CHIPPINGS AND COLOURFUL POLYESTER RESIN.</p>	<p>SOLID AND ESTHETIC ROPE CONNECTORS MADE OF INJECTION MOLDED POLYAMIDE.</p>	<p>ROPE ENDINGS PRESSED IN A SLEEVE MADE OF DURABLE ALUMINIUM ALLOY.</p>
